

2.00"

INSTALLATION INSTRUCTIONS

3000 Lumens

IMPORTANT SAFEGUARDS

When using electrical equipment, basic safety precautions should always be followed including the following :

READ AND FOLLOW ALL SAFETY INSTRUCTIONS

1. Do not use outdoors.
2. Prior to installation, battery connector must be open to prevent high voltage from being present on output leads (red & yellow).
3. For use with 20-40W, T9, T10, T12; 17-32W T8 fluorescent lamps, and 17-42W Long Compact fluorescent lamps operates ONE or TWO lamps in emergency mode for a minimum of 90 minutes.
CNL ONLY-ONE 18-215W fluorescent lamp.
4. Please ensure the electricity connections conforms to the National Electrical Code and local regulations if applicable.
5. To avoid electric shock, please disconnect normal and emergency power supplies, and battery connector of the emergency ballast before servicing.
6. This device is designed for factory or field installation in either the ballast channel, or on top of the indoor fixture, except air handling heated air outlets, wet or hazardous location fixtures.
7. Do not install this device near gas or electric heaters.
8. AC power source of 120 VAC or 277 VAC is required.
9. The battery is sealed, non-maintenance, and is not replaceable in the field. Please contact manufacturer for information on service. Do not attempt to service the battery please.
10. The use of accessory equipment not recommended by the manufacturer may cause an unsafe condition.
11. Do not use this equipment for other than its intended use.
12. Equipment should be mounted in locations and at heights where it will not be subjected to tampering by unauthorized personnel.

PLEASE SAVE THESE INSTRUCTIONS

INSTALLATION INSTRUCTIONS

NOTE: All the branch circuit wiring has to be ready as well as an unswitched source of power before the fixture is installed. Confirmed the same branch circuit would match the emergency ballast as AC ballast.

CAUTION: Inverter connector has to be opened for preventing high voltage on output leads (Red and Yellow). Wait until all the installation process is completed and AC is supplying power to the emergency ballast then join the inverter connector.

1. AC power has to be off before installation.
2. Choose the right wiring diagram to connect the emergency ballast to AC ballast and lamp.
3. Please ensure the electricity connections conform to the National Electrical Code and local regulations if applicable. To install the emergency ballast on top of the fixture, refer to Diagram 1. To install the emergency ballast remotely, **DIAGRAM 1** refer to Diagram 3. Emergency ballast may be installed up to half of the distance the AC ballast manufacturer recommends or up to 50 feet, whichever one is closer.

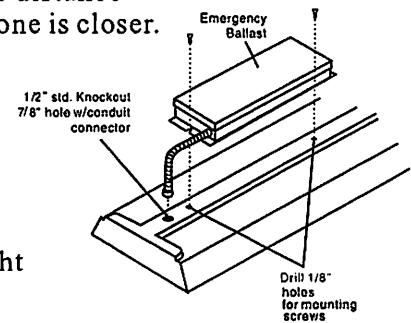

4. To install the test switch, it would go through the side of a strip fixture or the ballast channel cover of a troffer. Follow diagram 4 to drill a 1/2 inch hole and install the test switch. In order to remove AC power from both the emergency ballast and the AC ballast, test switch has to be connected properly (Check diagram 2).

5. Matching violet and brown leads to connect the charging indicator light to the emergency ballast (Check diagram 4).

6. "CAUTION: This Unit Has More Than One Power Supply Connection Point. To Reduce The Risk Of Electric Shock, Disconnect Both The Branch Circuit-Breakers Or Fuses And Emergency Power Supplies Before Servicing". Label must be placed in a readily visible location.

DIAGRAM 2

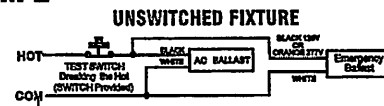

7. Do not connect the inverter connector until the fixture is completely installed and supply AC power to the emergency ballast.

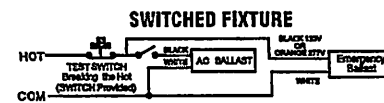

8. The battery needs to be charged for one hour in order to have short-term testing on the emergency function. Before having a long-term emergency function testing, the battery in emergency ballast has to be charged for 24 hours.

DIAGRAM 3

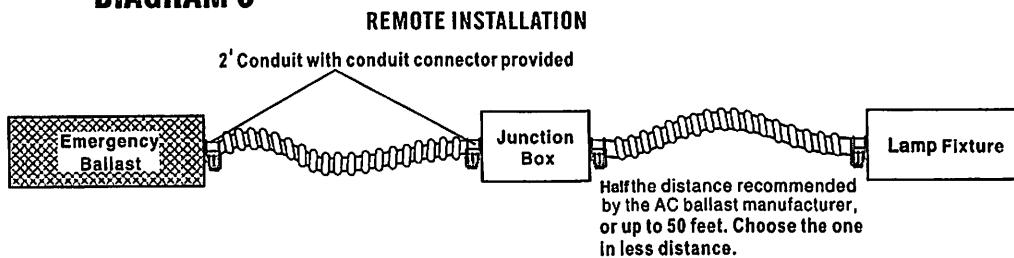

- Note:**
- 1 - Please be advised the inverter connector and lamp selector brown lead CAN NOT be extended.
 - 2 - For remote installation. Be sure to use conduit and junction box. (Not supplied)

DIAGRAM 4

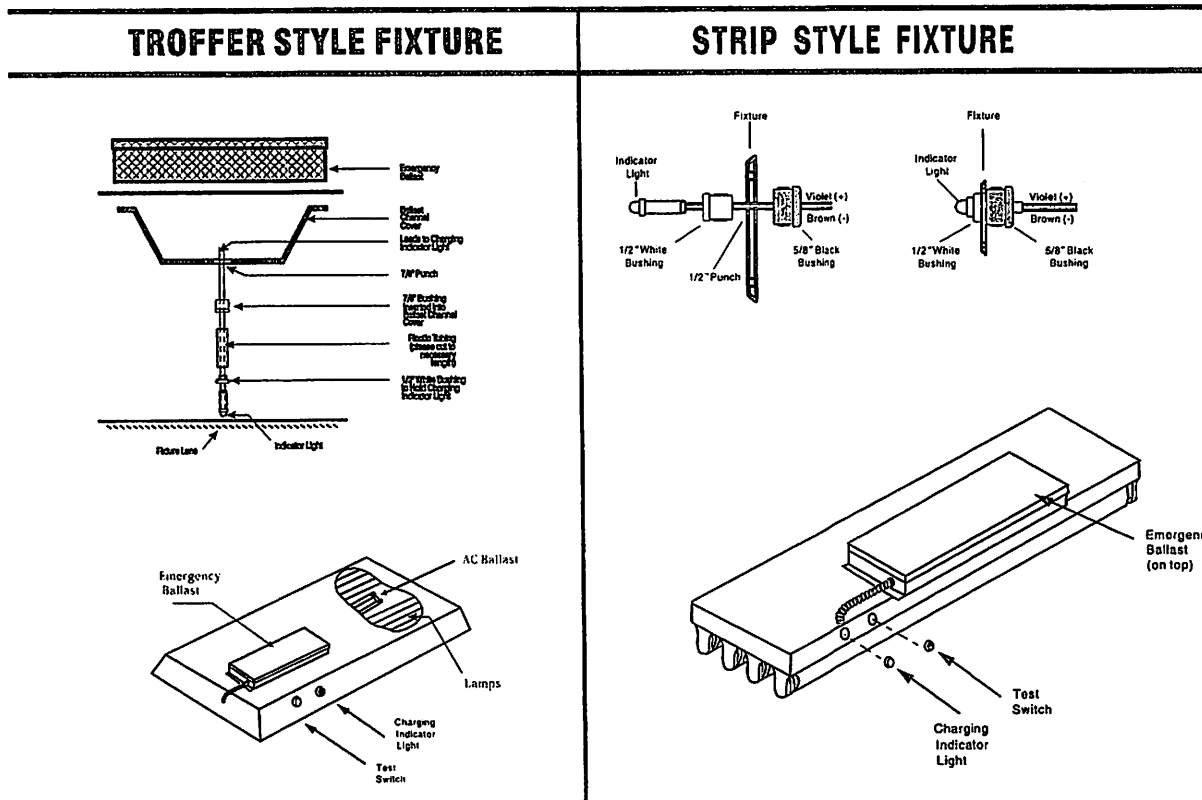

NOTE: After installing the charging indicator light and test switch, mark each with the appropriate label.

OPERATION:

THE CHARGING INDICATOR LIGHT WOULD BE ON TO INDICATE THE BATTERY IS BEING CHARGED WHEN AC POWER IS APPLIED.

THIS EMERGENCY BALLAST WOULD FUNCTION AND OPERATE ONE OR TWO LAMPS AT LEAST 90 MINUTES WHEN THE AC POWER HAS FAILED.

THE DEVICE OF THIS EMERGENCY BALLAST WILL OPERATE 17 WATT TO 215 WATT LAMPS AT LEAST 90 MINUTES.

MAINTENANCE:

NOTE: SERVICES SHOULD ONLY BE PERFORMED BY QUALIFIED PERSONNEL.

THE EMERGENCY BALLAST SHOULD BE CHECKED PERIODICALLY TO CONFIRM FUNCTIONING AND THE FOLLOWING SCHEDULE IS RECOMMENDED.

- 1) TO INSPECT THE CHARGING INDICATOR EVERY MONTH AND CONFIRM THAT IS ILLUMINATED.
- 2) PUSH THE TEST SWITCH FOR 30 SECONDS TO ENSURE THE EMERGENCY BALLAST IS FUNCTIONING. RECOMMENDED TO PERFORM THIS TESTING IN EVERY 30 DAYS.
- 3) PERFORMING A LONG-TERM TEST (90 MINUTE BATTERY DISCHARGE) IN EVERY YEAR. ONE OR TWO LAMPS SHOULD BE OPERATED FOR NO LESS THAN 90 MINUTES.
- 4) BEFORE THE BATTERY IS REPLACED, DISCONNECT INVERTER CONNECTOR, SWITCHED AC POWER AND UNSWITCHED AC POWER FROM THE FIXTURE. AFTER THE BATTERY IS REPLACED, SUPPLY THE AC POWER TO THE FIXTURE AND RECONNECT INVERTER CONNECTOR. THE CHARGING INDICATOR SHOULD BE ON AFTER THE BATTERY IS REPLACED. IF THE BATTERY NEEDS TO BE REPLACED, CONTACT THE MANUFACTURER.

WIRING DIAGRAMS:

The following diagrams are typical schematics only. May be used with other ballasts. Consult the factory for other wiring diagrams. Emergency Ballast and AC Ballast must be fed from the SAME BRANCH CIRCUIT.

TABLE 1 (FOR BROWN CONNECTOR)
ONLY APPLICABLE TO UNIT INSTALLED IN CANADA

LAMP DIAMETER	1-1/4", 1-1/2" (T9, T10, T12)		LONG COMPACT			1" T8		2D			
BASE TYPE	SINGLE OR BIPIN		4-PIN (2G11)			SINGLE OR BIPIN		4-PIN (GR10q)			
WATTAGE (LENGTH)	20-40W (2'-4')		18-215W (5'-8')		18-39W	40-55W	17-32W		16-38W		55W
NO. OF LAMPS (EMERGENCY MODE)	1	2	1	1	2	1	1	2	1	2	1
BROWN CONNECTOR	CLOSE	OPEN	OPEN	CLOSE	OPEN	OPEN	CLOSE	OPEN	CLOSE	OPEN	OPEN

***Brown Connector Shall Be Disconnected at all times when unit in installed in the United States.**

WIRING DIAGRAMS FOR 1-LAMP EMERGENCY OPERATION

EMERGENCY BALLAST AND AC BALLAST MUST BE FED FROM THE SAME BRANCH CIRCUIT

TYPICAL SCHEMATICS ONLY. MAY BE USED WITH OTHER BALLASTS. CONSULT THE FACTORY FOR OTHER WIRING DIAGRAMS.

A. ONE (1) LAMP RAPID START BALLAST

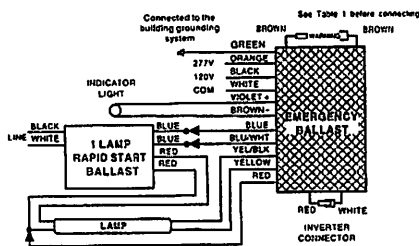

B. TWO (2) LAMP RAPID START BALLAST

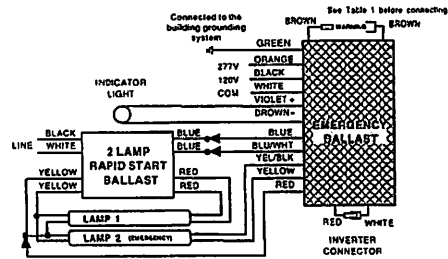

C. THREE (3) LAMP RAPID START BALLAST

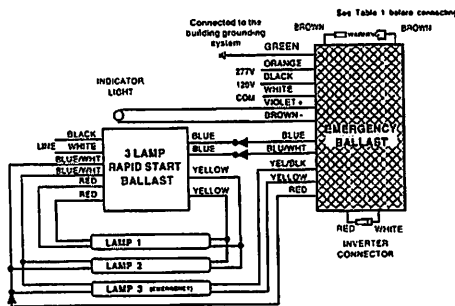

D. FOUR (4) LAMP RAPID START BALLAST

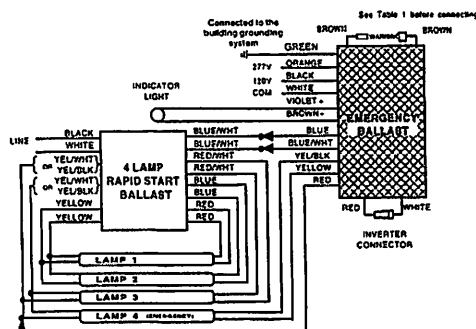

NOTE : TO UNUSED LEAD USE THE PROPER TAP CAP TO UNSWITCHED AC LEAD.

WIRING DIAGRAMS FOR 1-LAMP EMERGENCY OPERATION

EMERGENCY BALLAST AND AC BALLAST MUST BE FED FROM THE SAME BRANCH CIRCUIT
 TYPICAL SCHEMATICS ONLY. MAY BE USED WITH OTHER BALLASTS. CONSULT THE FACTORY FOR OTHER WIRING DIAGRAMS.

E. ONE (1) LAMP INSTANT START BALLAST

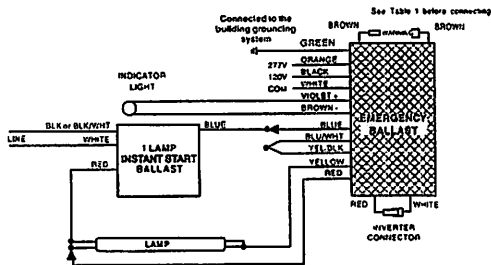

F. TWO (2) LAMP INSTANT START BALLAST

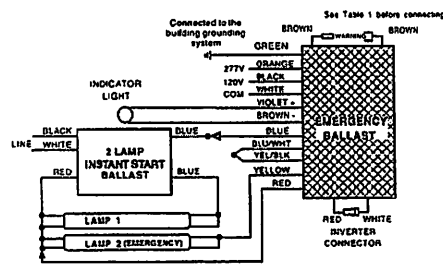

G. THREE (3) LAMP INSTANT START BALLAST

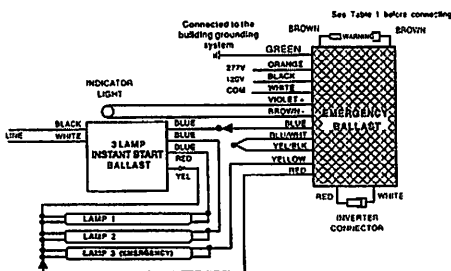

H. FOUR (4) LAMP INSTANT START BALLAST

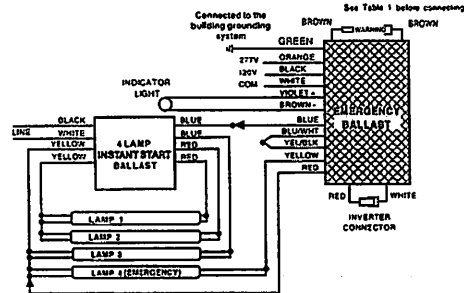

I. ONE (1) 4-PIN COMPACT LAMP RAPID START BALLAST

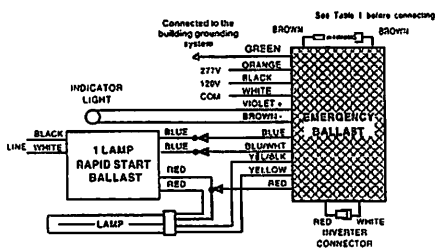

J. TWO (2) 4-PIN COMPACT LAMP RAPID START BALLAST

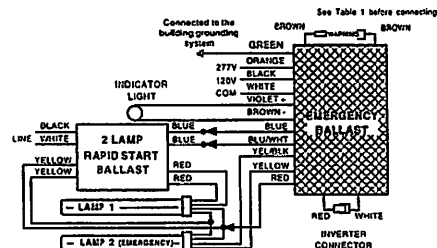

K. ONE (1) LAMP CIRCLINE REPID START BALLAST

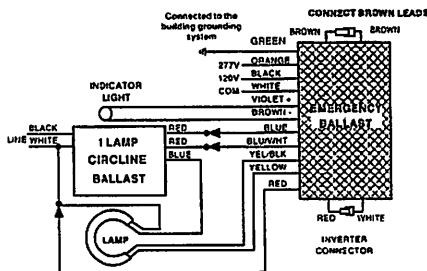

L. TWO (2) LAMP CIRCLINE REPID START BALLAST

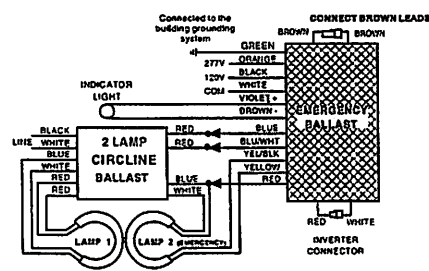

NOTE : TO UNUSED LEAD USE THE PROPER TAP CAP TO UNSWITCHED AC LEAD.

WIRING DIAGRAMS FOR 2-LAMP EMERGENCY OPERATION

EMERGENCY BALLAST AND AC BALLAST MUST BE FED FROM THE SAME BRANCH CIRCUIT

TYPICAL SCHEMATICS ONLY. MAY BE USED WITH OTHER BALLASTS. CONSULT THE FACTORY FOR OTHER WIRING DIAGRAMS.

Two-lamp emergency operation is not possible with all ballasts.
Consult the factory for any ballast other than those shown.

M. TWO (2) LAMP RAPID START BALLAST

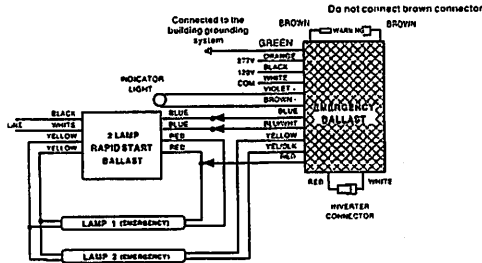

N. TWO (2) LAMP INSTANT START BALLAST

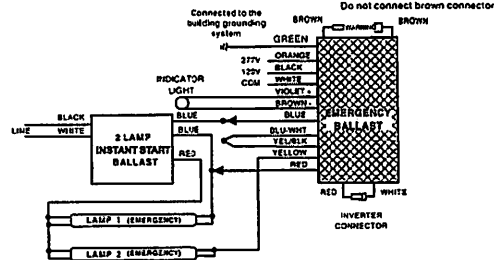

O. THREE (3) LAMP RAPID START BALLAST

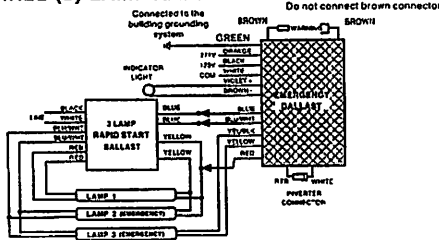

P. THREE (3) LAMP INSTANT START BALLAST

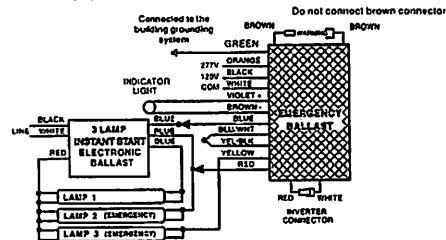

Q. FOUR (4) LAMP RAPID START BALLAST

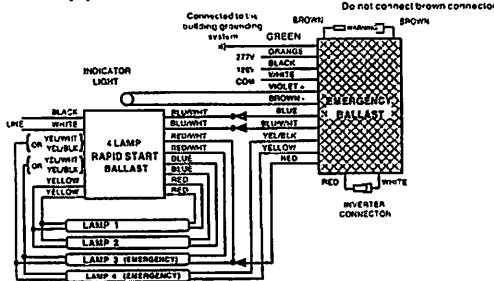

R. FOUR (4) LAMP INSTANT START BALLAST

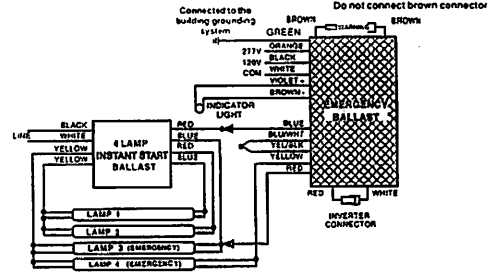

WIRING DIAGRAMS for EMERGENCY-ONLY fixtures

S. ONE (1) LAMP WITHOUT AC BALLAST

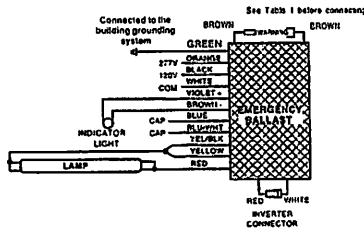

T. TWO (2) LAMPS WITHOUT AC BALLAST

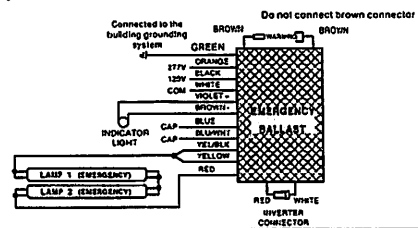

U. ONE (1) 4-PIN COMPACT LAMP WITHOUT AC BALLAST

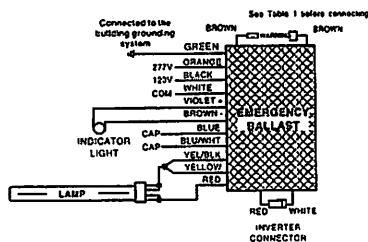

V. TWO (2) 4-PIN COMPACT LAMPS WITHOUT AC BALLAST

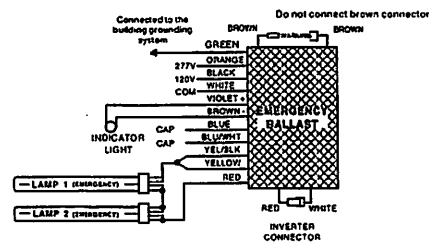

NOTE: TO UNUSED LEAD USE THE PROPER TAP CAP TO UNSWITCHED AC LEAD.